

Ciclo di convegni

SOSTENIBILITA' E VALORIZZAZIONE DEL PATRIMONIO EDILIZIO

# VALUTAZIONE LCA ED EPD DEL SETTORE DELLE COSTRUZIONI

18 giugno 2014

Organizza

**MDS**  
MACRO  
DESIGN  
STUDIO

solutions for sustainable  
architecture

In collaborazione con



**ROCKWOOL**  
FIRESAFE INSULATION

Con il patrocinio di

*fondazione*  
architetti  
e ingegneri  
liberi  
professionisti  
iscritti  
INARCASSA



Ordine degli Architetti  
Pianificatori, Paesaggisti  
e Conservatori  
della Provincia di Trento



Collegio dei Periti Industriali e  
dei Periti Industriali Laureati  
della Provincia di Trento

In cooperazione con



Relatore  
**Alessandro Miliani – ingegnere**  
**Xella Italia S.r.l.**

**SISTEMI COSTRUTTIVI MINERALI**  
*Focus sul tema della sostenibilità*



**YTONG**<sup>®</sup>

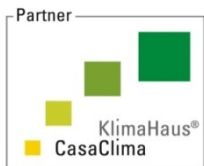

AM ©



<b>Produzione e commercializzazione prodotti in AAC e calcio silicato</b>	<b>Produzione e commercializzazione di sistemi a secco in gessofibra</b>	<b>Leader mondiale nella produzione di materie prime</b>
---	--	--

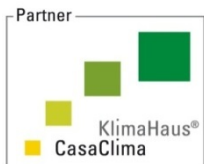

AM ©

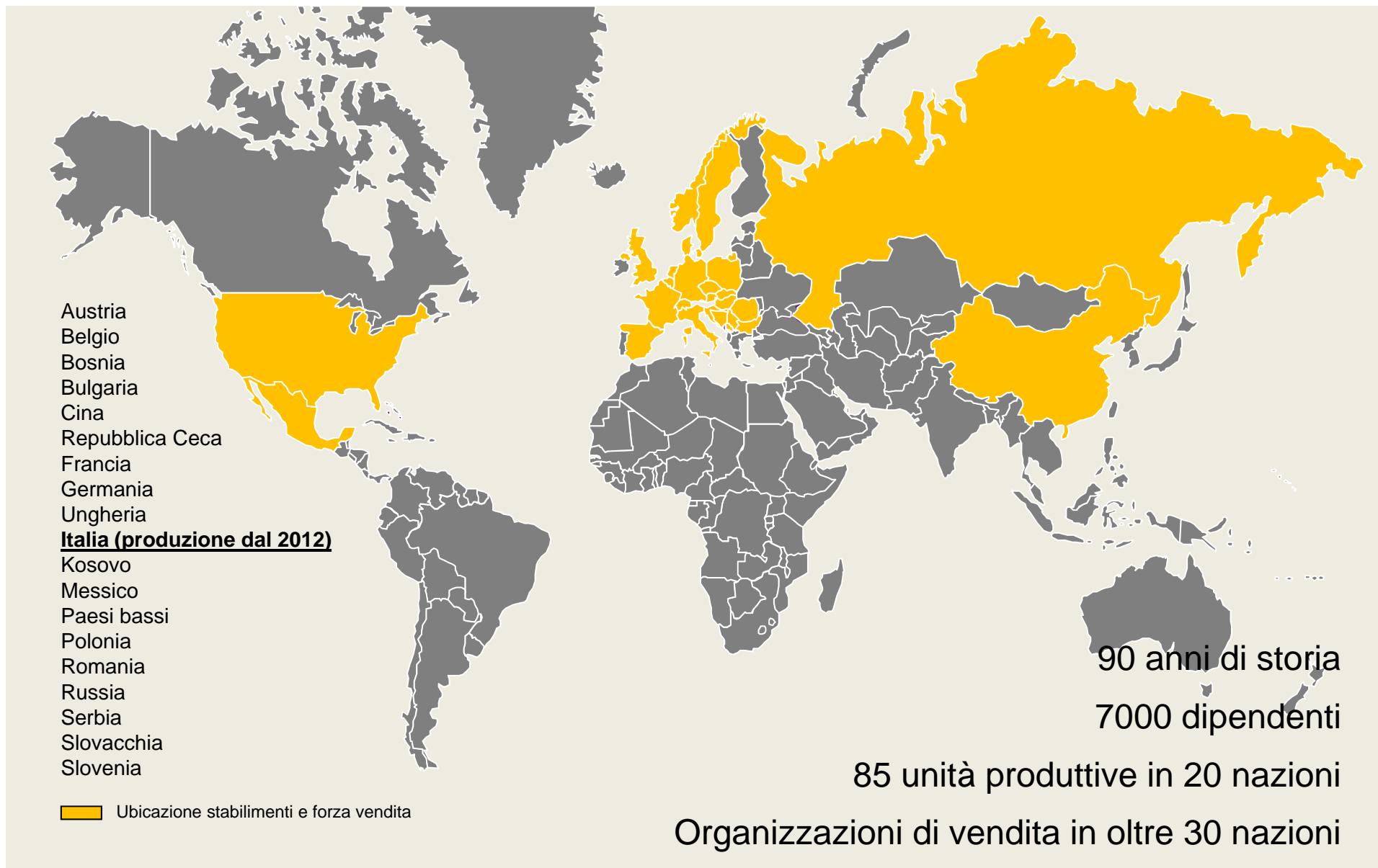

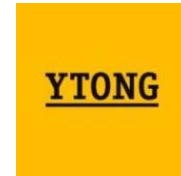
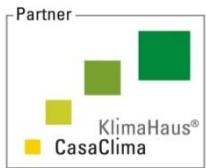

AM ©

# Il sistema costruttivo YTONG

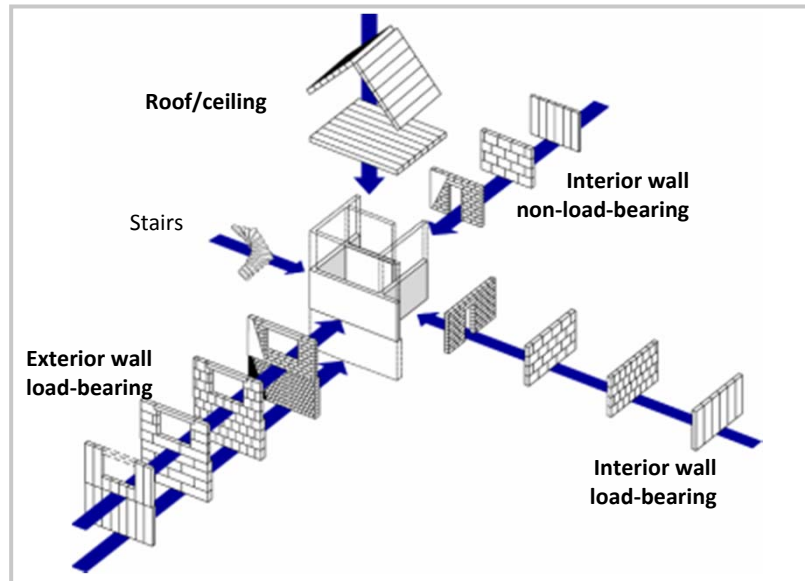

Exterior wall structures - overview

 Solid state (+ plaster)	 Single-wall + facing bricks	 With heat insulation and facing bricks
 Wall with thermal insulation composite system	 Skeleton construction	 Interior insulation

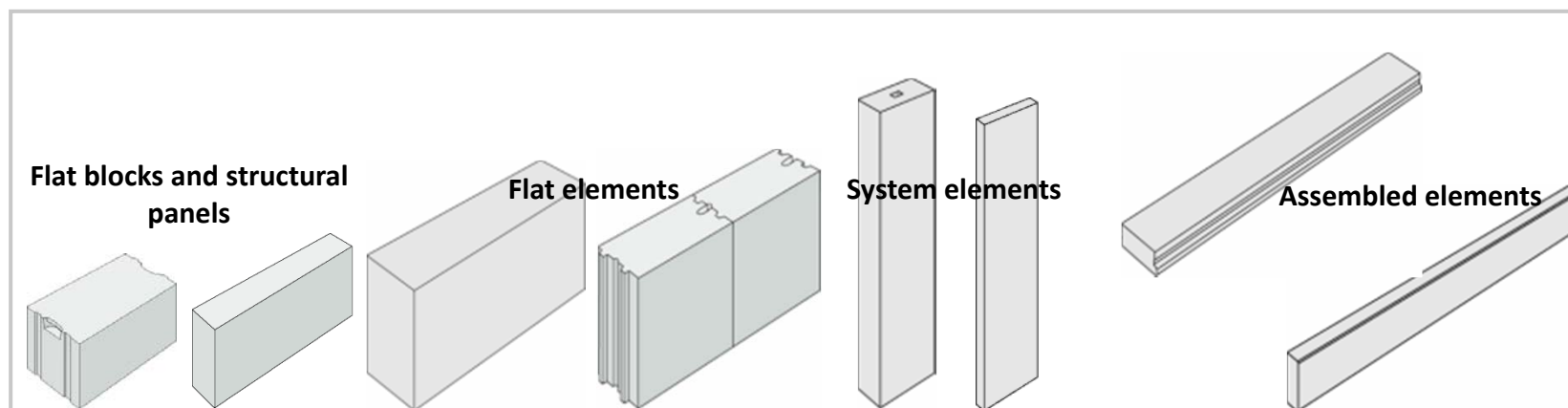

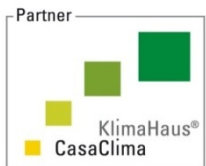

AM ©

Residenziale

### La casa ideale

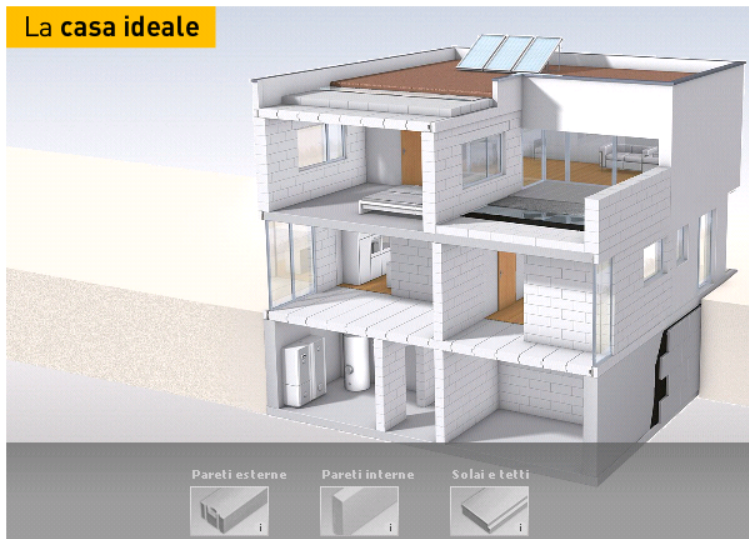

Industriale

### Resistenza e sicurezza



# SISTEMA COSTRUTTIVO COMPLETO!

## Idoneo per qualsiasi applicazione

Ristrutturazione

### Riqualificazione energetica

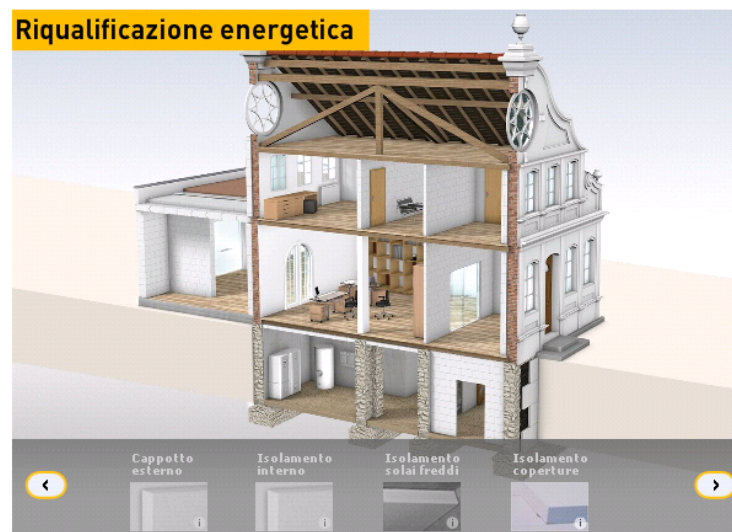

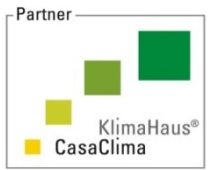

AM ©



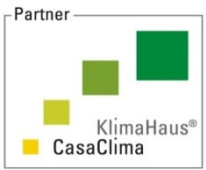

AM ©

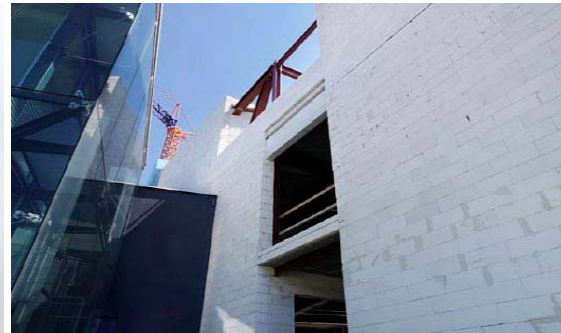



# Cos'è l'AAC ?



**YTONG**

sabbia + calce + cemento + acqua  
e polvere di alluminio porizzante

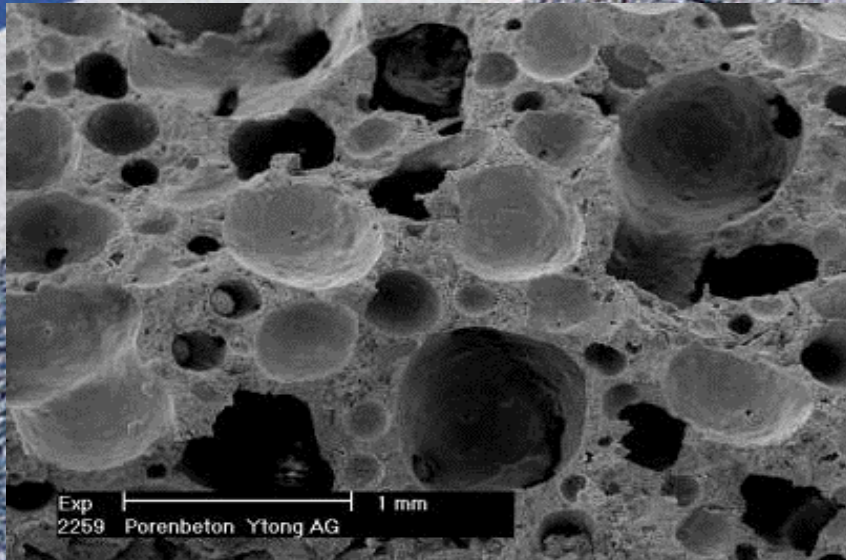

**AAC – Autoclaved Aerated Concrete**  
**Calcestruzzo Aerato Autoclavato**

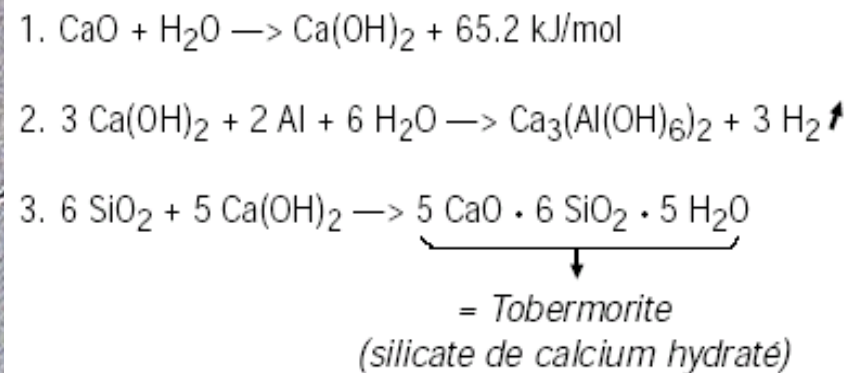

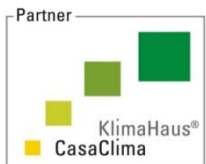

AM ©

# Composizione

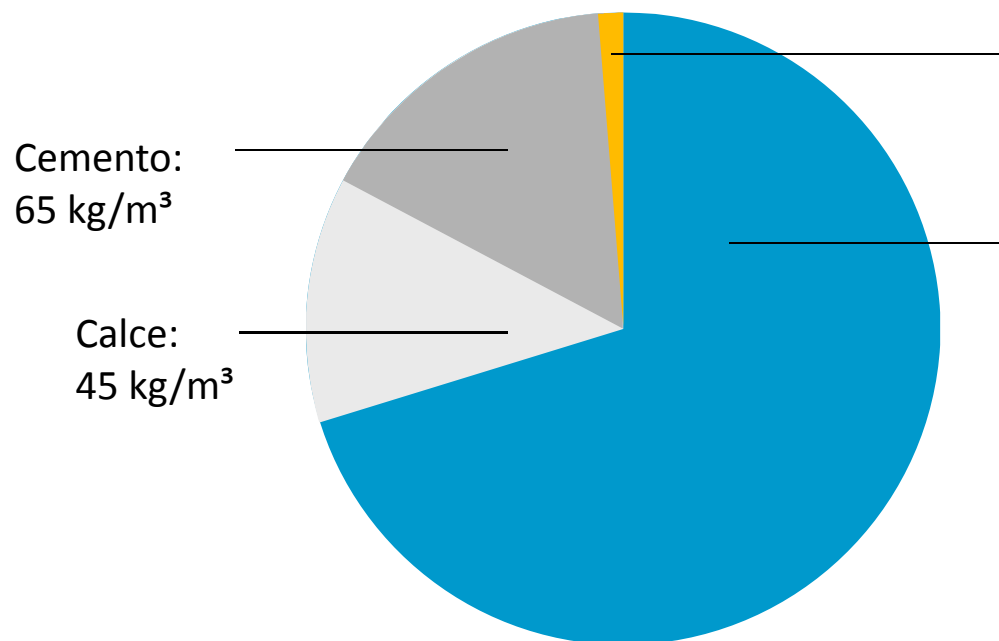

Aluminio:  
0.5 kg/m<sup>3</sup>

Sabbia:  
290 kg/m<sup>3</sup>

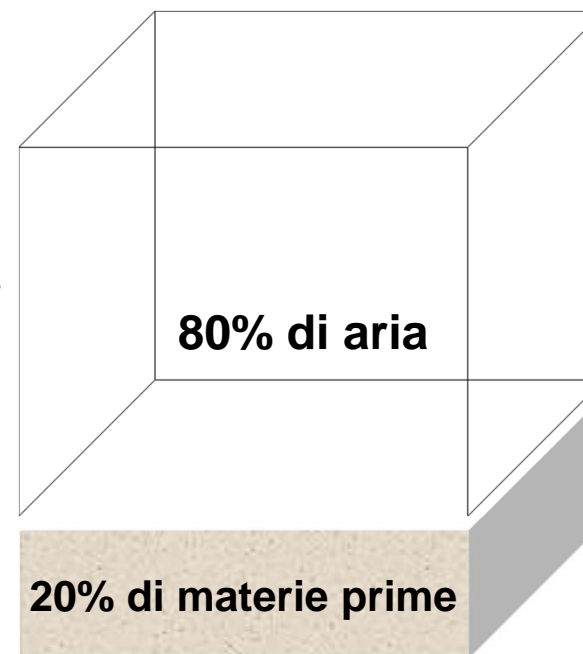

**400 kg di materie prime per 1m<sup>3</sup> di calcestruzzo cellulare**

**1 m<sup>3</sup> di materie prime per 4-5 m<sup>3</sup> di calcestruzzo poroso**

Il calcestruzzo aerato autoclavato è simile ad una pietra naturale: la **tobermorite**

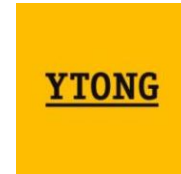
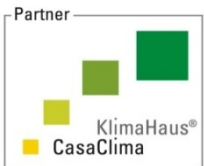

AM ©

# xella® Sustainability Report 2012



## Ytong – the Original in Thermal Insulation

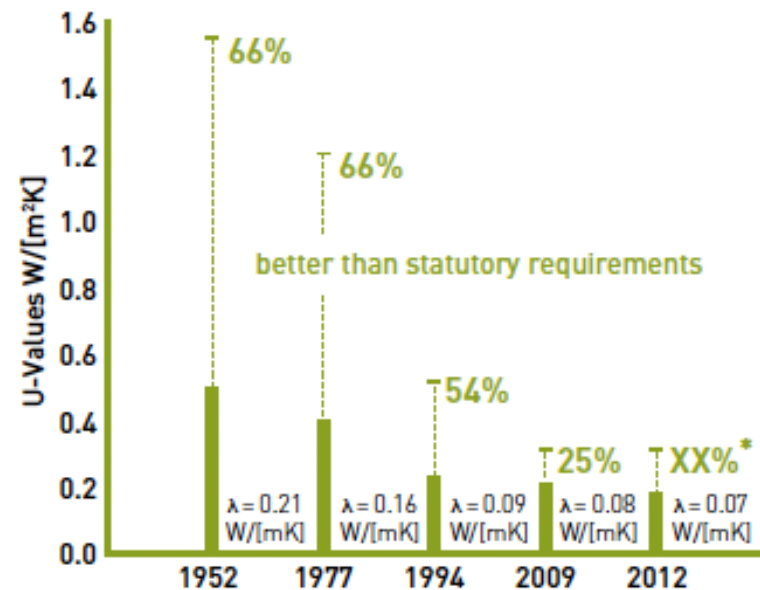

† Statutory maximum value (Germany)

■ U-value of a wall made with Ytong blocks, wall thickness: 36.5 cm

% Amount below statutory maximum in percent

U-value: Heat transfer coefficient

Lambda (λ)-value: Thermal conductivity value

\* binding EnEV reference value for 2012 unknown at time of printing

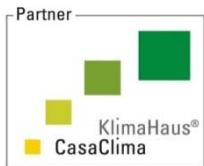

AM ©

## Storia AAC (da WIKIPEDIA)

Il primo tentativo di produrre un calcestruzzo alleggerito fu brevettato in Cecoslovacchia da E. Hoffman nel 1889. L'aerazione era prodotta da ... . Nel 1914 Aylsworth & Dyer, negli U.S.A., usarono alluminio in polvere e idrossido di calcio come agenti aeranti. ....

La **polvere di alluminio** si affermò come il mezzo che produceva la più controllabile aerazione con il rilascio di bolle di idrogeno in una consistente gamma di dimensioni (**alto isolamento termico**). Molte di queste tecniche diedero però risultati insoddisfacenti, con materiali aventi bassa resistenza a compressione e friabilità, generalmente inadatti ad applicazioni strutturali. [3]

Negli anni venti, **in Svezia, a causa di un'eccessiva carenza di legname da costruzione dovuta alla deforestazione**, l'architetto Johan Axel Eriksson intraprese ricerche su **materiali da costruzione alternativi**; nel **1923**, per sveltire la stagionatura dei campioni di calcestruzzo decise di utilizzare un'autoclave, ottenendo quindi un risultato totalmente inatteso, con **un'ottima resistenza a compressione** [4].

Nel 1924 Eriksson brevettò il suo procedimento con il nome di "**poren betong**" (in svedese **cemento poroso**) [4], e nel 1929 lo commercializzò sotto il nome "**Ytong**".



**II CALCESTRUZZO POROSO  
come alternativa al  
LEGNO**

- non brucia
- non deperisce con l'acqua
- facilmente lavorabile
- leggero e isolante



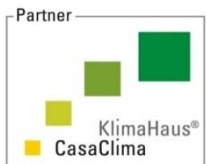

AM ©

# Caratteristiche tecniche e densità

meno  
massa

più  
massa



## MURATURA DI TAMPONAMENTO

Prevale la performance termica

MURATURA PORTANTE  
Prevale il requisito statico (serve isolante aggiuntivo)

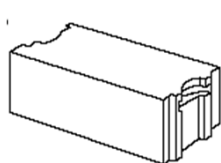
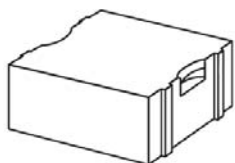
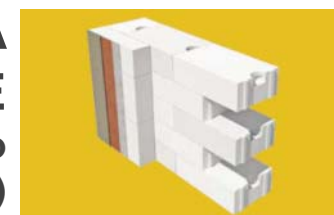

CLIMAGOLD 0,08 - CLIMA 0,10

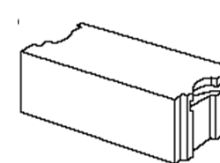

THERMO 0,12 - SISMICO 0,15

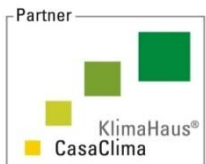

AM ©

## Materie prime usate per produrre 1 m<sup>3</sup> di materiale

kg/m<sup>3</sup>

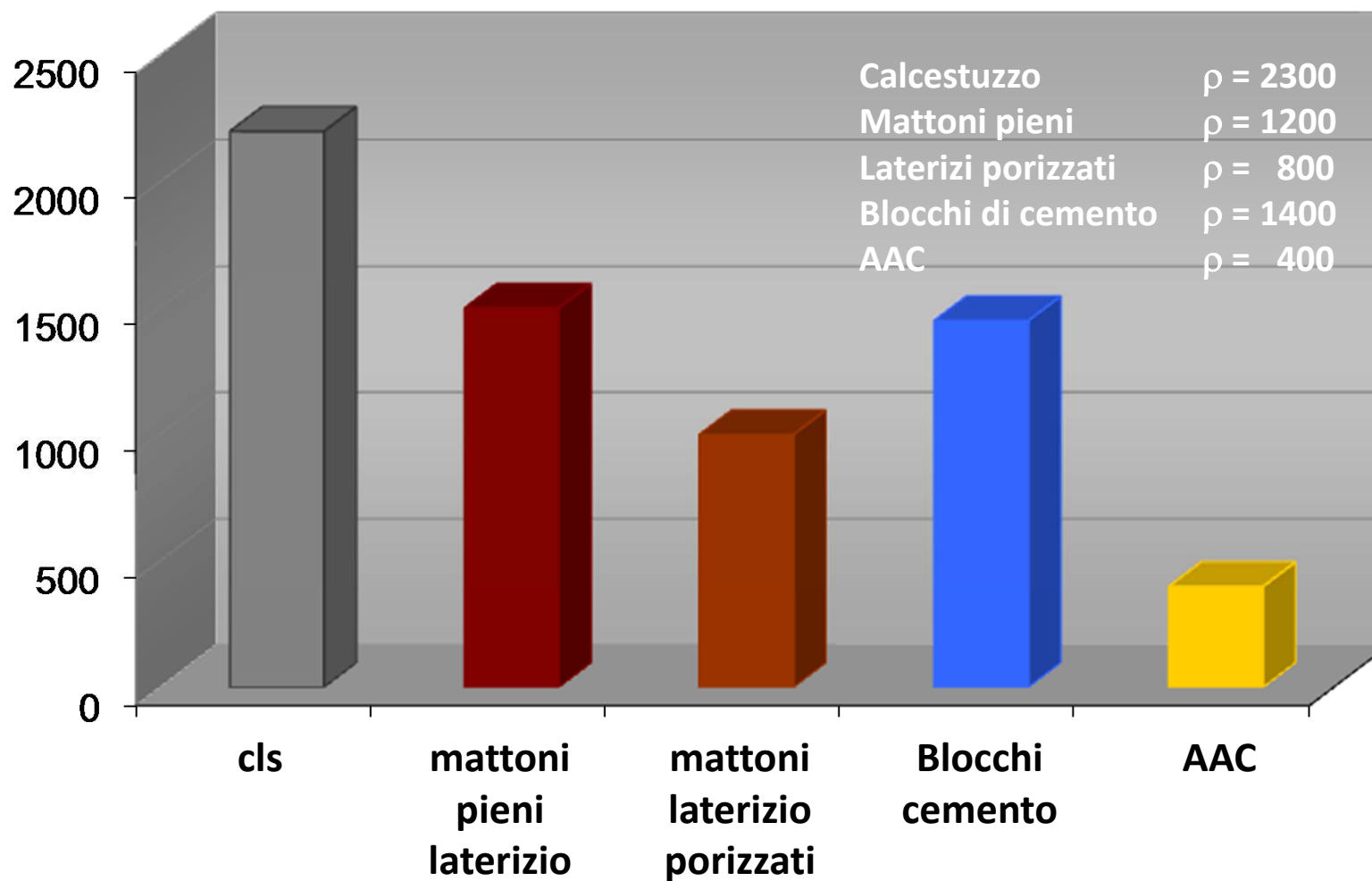

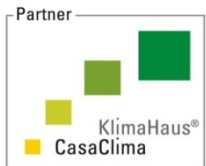

AM ©

# La produzione del calcestruzzo cellulare

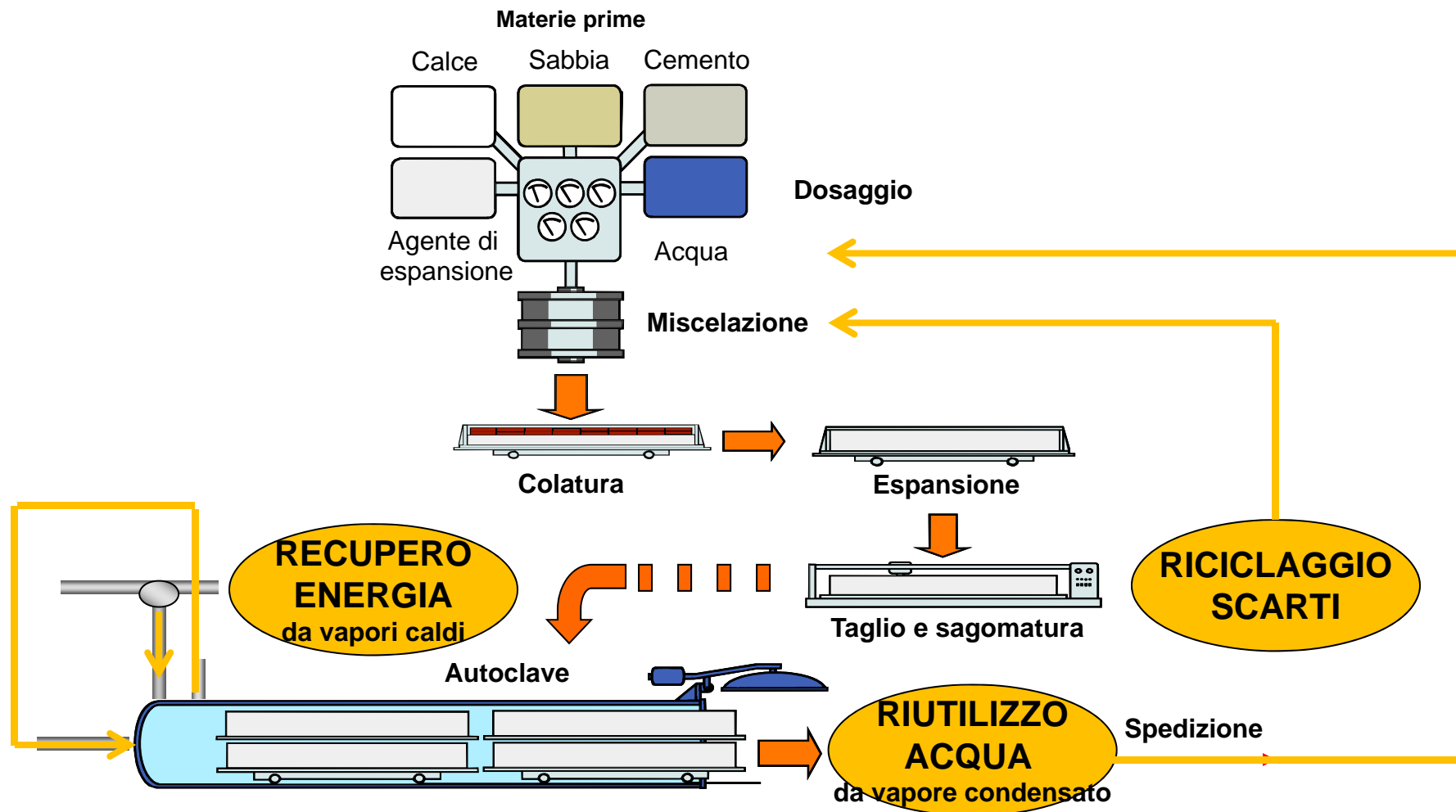

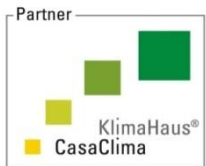

AM ©

# Energia consumata per produrre 1 m<sup>3</sup> di materiale

kWh/m<sup>3</sup>

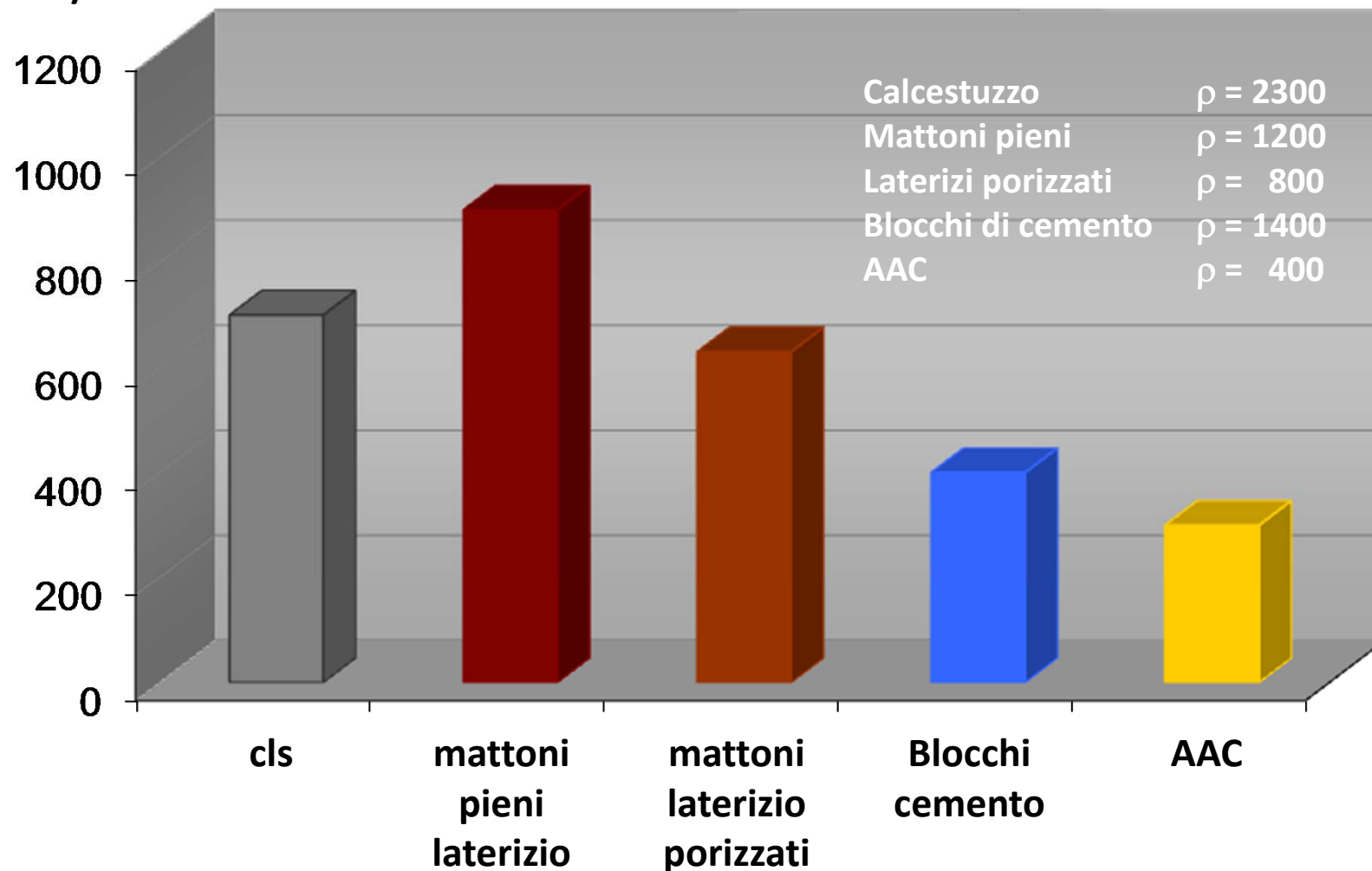



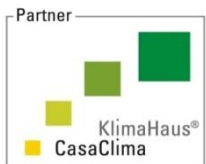

AM ©

## Certificazioni ambientali e salubrità di YTONG:

- EPD
- Natureplus
- Cradle to Cradle
- DUBOKEUR
- Sentinel - Haus



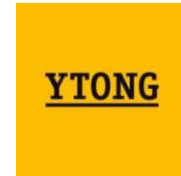
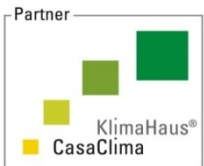

AM ©

# EPD – Enviromental Product Declaration



**YTONG**  
Autoclaved Aerated Concrete  
from Xella Baustoffe GmbH

Declaration number  
AUB-XEL-11005-E



ARBARBEITSGEMEINSCHAFT UMWELTVERTRÄGLICHES BAUPRODUKT E.V.  
[www.bau-umwelt.com](http://www.bau-umwelt.com)



**MULTIPOR** Pannello isolante minerale  
di Xella Dämmsysteme GmbH

Numero di dichiarazione  
AUB-XEL-20506-IT



ARBARBEITSGEMEINSCHAFT UMWELTVERTRÄGLICHES BAUPRODUKT E.V.  
[www.bau-umwelt.com](http://www.bau-umwelt.com)



**Hebel® - Bewehrter Porenbeton**  
Xella International GmbH

Deklarationsnummer  
EPD-XEL-2010511-0

Institut Bauen und Umwelt e.V.  
[www.bau-umwelt.com](http://www.bau-umwelt.com)



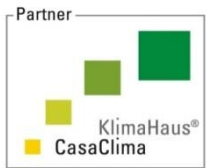

AM ©

# EPD – Enviromental Product Declaration (BLOCCHI)

## 7.2 Description of the balances and analyses

Life Cycle Inventory (LCI)

Table 2 shows the primary energy consumption (renewable and non-renewable) for the production of 1 m<sup>3</sup> YTONG – AAC for both gross density categories P2 and P4.

Table 2: Primary Energy Consumption for the Production of 1 m<sup>3</sup> YTONG – AAC

YTONG - AAC P2 0.40 und P4 0.50			
Indicator	Unit per m <sup>3</sup>	P2 0.40	P4 0.50
Primary energy, non-renewable	[MJ]	1427.0	1683.3
Primary energy, renewable	[MJ]	74.3	75.6

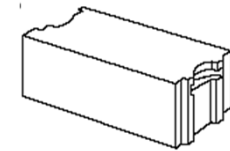

**YTONG Klima**

350 kg/mc

λ 0,098

Breakdown of primary energy consumption

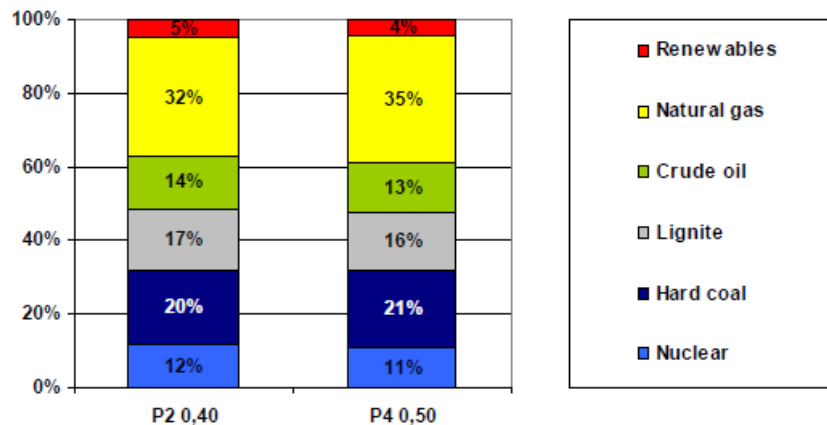

La maggior parte del consumo di energia prima deriva dall'impiego di **gas metano** (per produrre vapore in autoclave), seguita da **carbone, lignite e petrolio** (per materie prime)

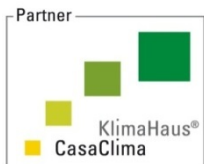

AM ©

# EPD – Enviromental Product Declaration (BLOCCHI)

YTONG – Autoclaved Aerated Concrete P2 0.40 und P4 0.50			
Indicator	Unit per m <sup>2</sup>	P2 0.40	P4 0.50
Global Warming Potential (GWP 100)	[kg CO <sub>2</sub> -eqv.]	179	217
Ozone Depletion Potential (ODP)	[kg R11-eqv.]	10.0 * 10 <sup>-6</sup>	10.9 * 10 <sup>-6</sup>
Acidification Potential (AP)	[kg SO <sub>2</sub> -eqv.]	0.263	0.285
Eutrophication Potential (EP)	[kg PO <sub>4</sub> -eqv.]	0.044	0.049
Photochemical Ozone Creation Potential (POCP)	[kg Ethene-eqv.]	0.038	0.042

Figure 2: Comparative contributions of individual categories to the environmental impacts of 1 m<sup>3</sup> of YTONG – AAC P2 0.40 und P4 0.50

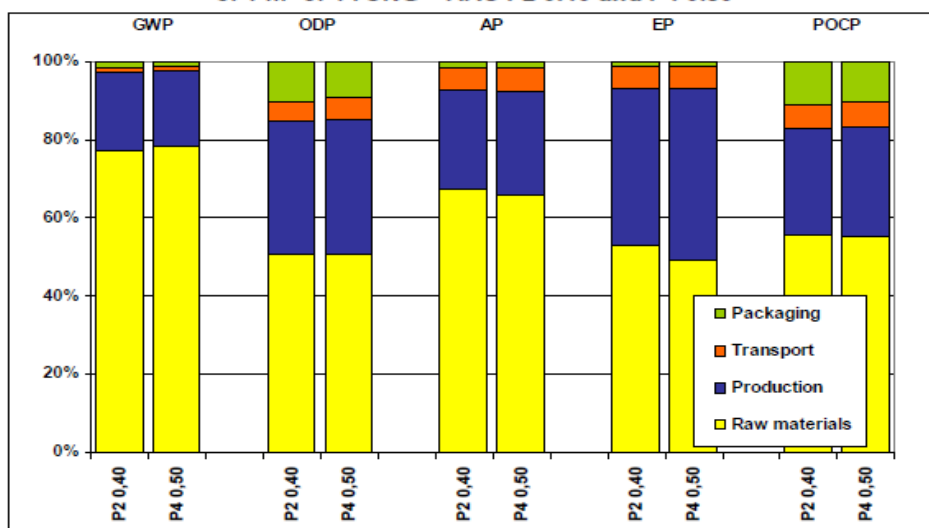

La produzione di **cemento e calce** contribuiscono oltre il 70% del GWP e oltre il 50% al potenziale di acidificazione (per entrambe le densità).

**Trasporto e packaging** sono di secondaria importanza.

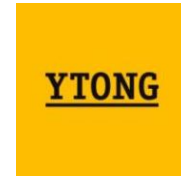
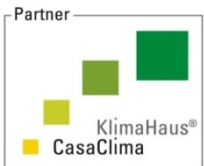

AM ©

# EPD – Enviromental Product Declaration

TIPOLOGIA DI PRODOTTO	DIMENSIONI			PRESTAZIONI TERMICHE			INDICATORI EPD					
	Lunghezza (m)	Altezza (m)	Spessore (m)	Conducibilità termica di progetto (W/mK)	Resistenza termica strato (m <sup>2</sup> ·K/W)	Trasmissione termica strato (seca inibiscia) (W/m <sup>2</sup> ·K)	PEI prodotto (MJ/m <sup>2</sup> )	GWP prodotto (kg CO <sub>2</sub> eq./m <sup>2</sup> )	ODP prodotto (CFC-11 eq./m <sup>2</sup> )	POCP prodotto (Cl <sub>2</sub> eq./m <sup>2</sup> )	AP prodotto (SO <sub>2</sub> eq./m <sup>2</sup> )	EP prodotto (PO <sub>4</sub> eq./m <sup>2</sup> )
BLOCCHI CLIMAGOLD	62,5	20,0	36,0	0,089	4,04	0,25	458	53	30	534	531	704
	62,5	20,0	40,0	0,089	4,49	0,22	509	59	34	593	590	782
	62,5	20,0	42,0	0,089	4,72	0,21	534	62	35	622	620	822
	62,5	20,0	48,0	0,089	5,39	0,19	611	71	40	711	708	939
							<b>E-9</b>	<b>E-5</b>	<b>E-4</b>	<b>E-5</b>		
BLOCCHI CLIMA	62,5	20,0	24,0	0,103	2,33	0,43	354	41	24	415	413	548
	62,5	20,0	30,0	0,103	2,91	0,34	445	51	29	519	517	685
	62,5	20,0	36,0	0,103	3,50	0,29	534	62	35	622	620	822
	62,5	20,0	40,0	0,103	3,88	0,24	594	69	39	692	689	913
							<b>E-9</b>	<b>E-5</b>	<b>E-4</b>	<b>E-5</b>		
BLOCCHI THERMO	62,5	25,0	20,0	0,137	1,44	0,69	424	49	28	494	492	652
	62,5	20,0	26,0	0,126	1,90	0,53	458	53	30	534	531	704
	62,5	20,0	30,0	0,126	2,38	0,42	572	66	38	667	664	880
	62,5	20,0	36,0	0,126	2,86	0,35	687	79	45	800	797	1056
	62,5	20,0	40,0	0,126	3,17	0,32	763	88	50	889	886	1174

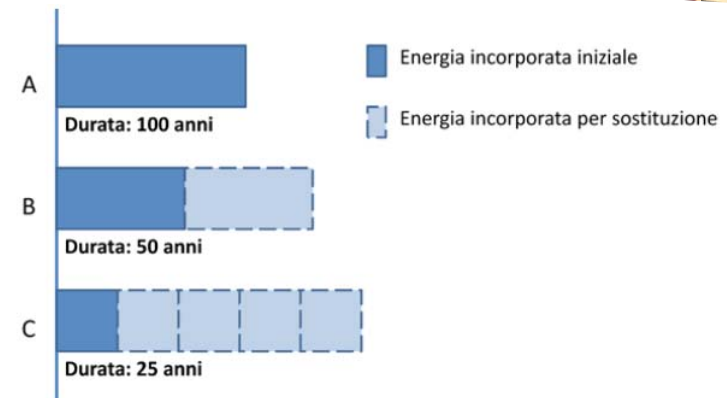
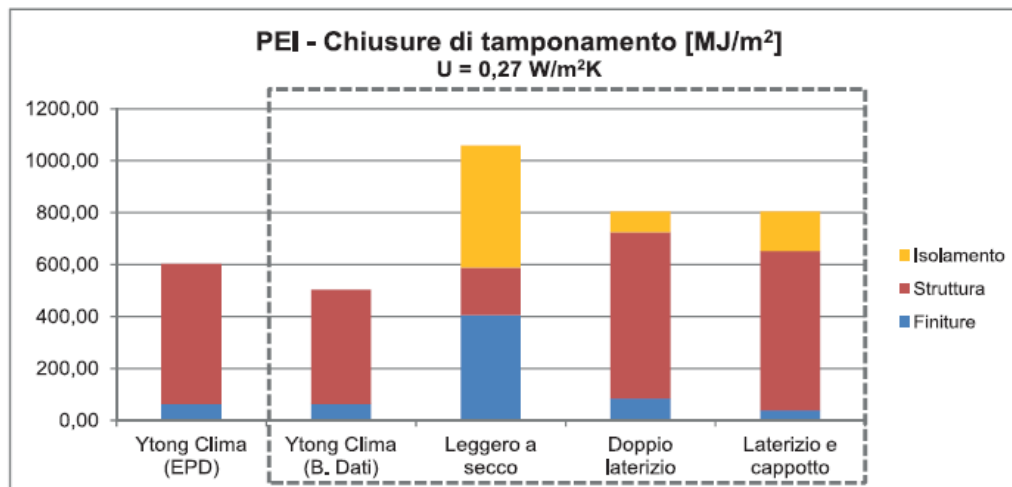

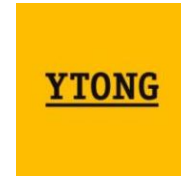
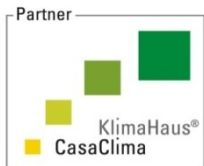

AM ©

# Natureplus®



**Il marchio natureplus® è sinonimo di rispetto per la salute, di produzione sostenibile, di risparmio di risorse naturali non rinnovabili e di facilità di posa in opera. I prodotti contrassegnati con questo marchio sono costituiti da materie prime rinnovabili o rigenerabili. Dei severi controlli ed i valori limite più restrittivi in Europa per le materie prime garantiscono che i prodotti certificati non presentano alcun rischio per l'uomo.**



natureplus  
Internationaler Verein für zukunftsfähiges  
Bauen und Wohnen e.V.

**ZERTIFIKAT**  
über die Vergabe des Qualitätszeichens  
**CERTIFICATE**  
for the award of the quality label  
**CERTIFICAT**  
pour l'attribution du label de qualité

certification pour construction et habitation durable de l'évenir

**Geprüfte Produkte**  
Tested products  
Produits testés

**Hersteller/Vertreiber**  
Manufacturer/Distributor  
Producteur/Distributeur

**Produktart**  
Type of product  
Nature du produit

**Zertifikatsnummer**  
Number of certificate  
Numéro de certificat

**Prüfumfang**  
Test program  
Étendue du test

**Prüfergebnis**  
Test result  
Résultat du test

**Gültigkeit des Zertifikats**  
Validity of certificate  
Validité du certificat

Neckargemünd, 2012-11-9

**YTONG blocs et carreaux de béton cellulaire**  
(usine de Saint-Savin)

**Geprüfte Produkte**  
Tested products  
Produits testés

**Hersteller/Vertreiber**  
Manufacturer/Distributor  
Producteur/Distributeur

**Produktart**  
Type of product  
Nature du produit

**Zertifikatsnummer**  
Number of certificate  
Numéro de certificat

**Prüfumfang**  
Test program  
Étendue du test

**Prüfergebnis**  
Test result  
Résultat du test

**Gültigkeit des Zertifikats**  
Validity of certificate  
Validité du certificat

Neckargemünd, 2008-12-20



natureplus  
Internationaler Verein für zukunftsfähiges  
Bauen und Wohnen e.V.

**ZERTIFIKAT**  
über die Vergabe des Qualitätszeichens  
**CERTIFICATE**  
for the award of the quality label  
**CERTIFICAT**  
pour l'attribution du label de qualité

certification pour construction et habitation durable de l'évenir

**Geprüfte Produkte**  
Tested products  
Produits testés

**Hersteller/Vertreiber**  
Manufacturer/Distributor  
Producteur/Distributeur

**Produktart**  
Type of product  
Nature du produit

**Zertifikatsnummer**  
Number of certificate  
Numéro de certificat

**Prüfumfang**  
Test program  
Étendue du test

**Prüfergebnis**  
Test result  
Résultat du test

**Gültigkeit des Zertifikats**  
Validity of certificate  
Validité du certificat

Neckargemünd, 2008-12-20

**Ytong Multipor Mineraldämmplatte**

**XELLA Dämmsysteme GmbH**  
D-47119 Dülmen  
Deutschland

**Mineralschaumplatte**  
Mineral foam board  
Plaque en mousse minérale

0404-0612-086-1

**Umwelt – Gesundheit – Funktion**  
Produktlebenslinie  
Laborprüfung (Inhaltsstoffe und Emissionen)  
Gebrauchstauglichkeit  
**Environment – Health – Function**  
Laboratory test (content and emissions)  
Fitness for use

**Umwelt – Gesundheit – Funktion**  
Produktlebenslinie  
Laborprüfung (Inhaltsstoffe und Emissionen)  
Gebrauchstauglichkeit  
**Environment – Health – Function**  
Laboratory test (content and emissions)  
Fitness for use

Das Produkt/die Produkte erfüllen die strengen Anforderungen der natureplus-Vergaberichtlinie RL0404 Mineralschaumplatten für Innen- und Außenanwendung  
The product/the products fulfill the stringent requirements of the natureplus award guideline RL0404 Mineral foam boards (external and indoor use)  
Le(s) produit(s) mentionné(s) ci-dessus rempli(remplissent) les exigences strictes des directives pour l'attribution de contrats de natureplus RL0404 Plaques en mousse minérale (utilisation intérieure et extérieure)

**Dezember / December / Décembre 2011**

*[Signature]*  
Prüfinstitut/ Test Institute/ Institut de Contrôle  
IBO GmbH, Wien

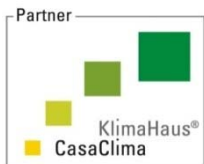

AM ©

# Sentinel Haus (VOC free) per blocchi e malta

## Valutazione peritale

Su richiesta della Xella Technologie- und Forschungsgesellschaft mbH, il prodotto calcestruzzo cellulare è stato sottoposto ad una misurazione delle emissioni nella camera di prova, ad un'ispezione olfattiva e a diverse analisi degli ingredienti.

I risultati documentati nel rapporto di prova vengono così valutati:

- il TCOV<sub>28d</sub> (totale dei composti organici volatili) era di 2,2 µg/m<sup>3</sup> ed è pertanto estremamente basso;
- SVOC (composti organici semi-volatili) e VVOC (composti organici molto volatili) non erano rilevabili;
- la formaldeide non era rilevabile;
- all'ispezione olfattiva è stato assegnato il voto 1 (odore non rilevabile);
- i composti organici alogenati non erano rilevabili;
- i metalli pesanti critici non erano rilevabili ovvero le concentrazioni si trovavano in un'area non significativa;
- i valori misurati per la radioattività erano molto bassi.



Produktprüfung  
Zertifizierung  
Qualitätssicherung



Il prodotto adempie ai requisiti relativi ai prodotti da costruzione a basse emissioni

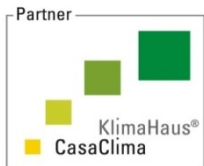

AM ©

## Cradle to Cradle®

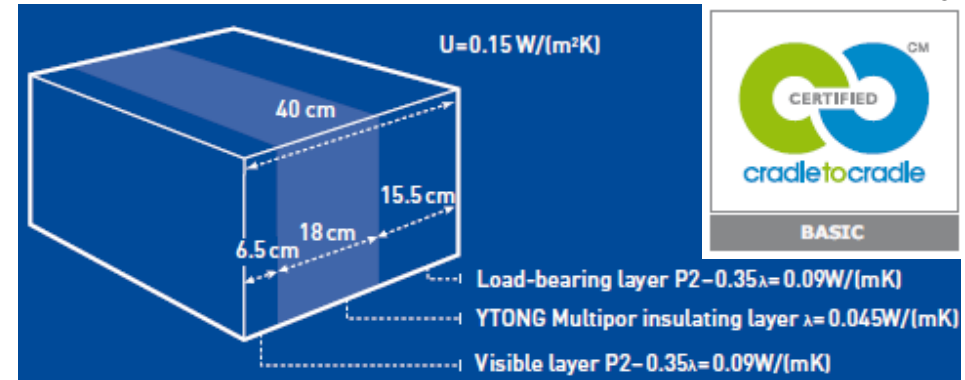

Ytong Energy+ ha ricevuto il certificato Cradle to Cradle nel 2011.

Questa certificazione dimostra il basso impatto ambientale durante tutto il ciclo di vita del prodotto, dalla produzione, al trasporto fino allo smaltimento

Ytong Energy+ è parte di un **ciclo chiuso**: materie prime minerali, recupero delle condense e polveri, **riutilizzo degli scarti come granulati o livellanti in edilizia**.

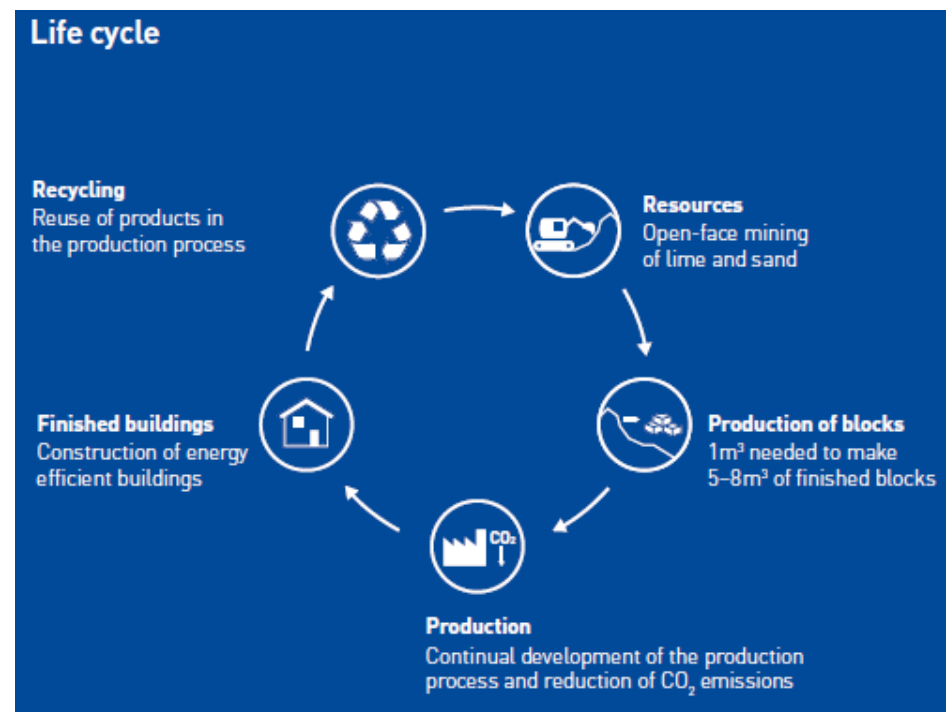



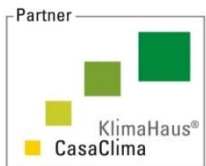

AM ©

I sistemi costruttivi energeticamente performanti sono (sempre) sostenibili?



Oggi? Domani?

...Separazione e riciclo ... ..Durabilità e sicurezza...

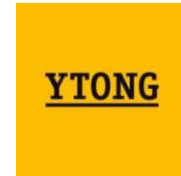
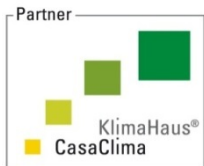

AM ©

# Crediti per LEED

## Hebel Autoclaved Aerated Concrete



LEED Credit	Intent of LEED Credit	Point Range for LEED Credit					
		New Construction		School		Core & Shell	
EA Prerequisite 2: Minimum Energy Performance - Option 1	Demonstrate a <u>10% improvement in the proposed building performance rating</u> for new buildings, or a 5% improvement in the proposed building performance rating for major renovations to existing buildings, compared with the baseline building performance rating.	1 of 3 points required for EA		1 of 3 points required for EA		1 of 3 points required for EA	
EA Credit 1: Optimize Energy Performance - Option 1	To achieve increasing levels of energy performance beyond the prerequisite standard to <u>reduce environmental and economic impacts</u> associated with excessive energy use.	1-19		1-19		3-21	
EA Credit 1: Exemplary Performance - Option 1 (Innovation in Design Credit 1)	Projects that use Option 1 and demonstrate a percentage improvement in the proposed building performance rating compared with the baseline building performance rating per ASHRAE 90.1-2007 by the following <u>minimum energy cost savings percentages</u> will be considered for 1 additional point under the Innovation in Design Category: - <u>New Buildings: 50%</u> - <u>Existing Building Renovation: 46%</u>	1 of 3		1 of 3		1 of 3	
MR Credit 2: Construction Waste Management	To divert construction and demolition debris from disposal in landfills and incineration facilities. Redirect recyclable recovered resources back to the <u>manufacturing process and reusable materials to appropriate sites.</u>	50%	75%	50%	75%	50%	75%
		1	2	1	2	1	2
MR Credit 2: Exemplary Performance (Innovation in Design Credit 1)	Project teams may earn an Innovation in Design credit for exemplary performance by <u>diverting 95% or more total construction waste.</u>	2 of 3		2 of 3		2 of 3	
MR Credit 5: Regional Materials	To increase demand for building materials and products that are extracted and <u>manufactured within the region (500 miles)</u> , thereby supporting the use of indigenous resources and reducing the environmental impacts resulting from transportation.	10%	20%	10%	20%	10%	20%
		1	2	1	2	1	2

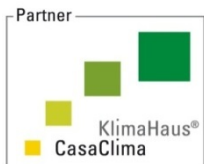

AM ©

# Crediti per LEED e ITACA



## INDICE

### PRIMA PARTE - Guida ANIT

0.	OBIETTIVO DELLA GUIDA	2
1.	IL CONCETTO DI SOSTENIBILITÀ APPLICATA ALL'EDILIZIA	3
	Le tre dimensioni della sostenibilità	4
2.	PERCHÈ INVESTIRE NELL'EDILIZIA SOSTENIBILE?	5
3.	LA CERTIFICAZIONE DI SOSTENIBILITÀ AMBIENTALE DELL'EDIFICIO	6
	Differenza tra certificazione ambientale e certificazione energetica	6
	Principali sistemi e metodologie di valutazione della sostenibilità	7
	Elementi di criticità della certificazione ambientale	7
4.	IL PROTOCOLLO ITACA 2011	8
	I materiali in ITACA	11
	Le declinazioni di ITACA nelle regioni di ITALIA	13
	Punti di forza nel sistema ITACA:	13
5.	IL SISTEMA DI VALUTAZIONE DELLA SOSTENIBILITÀ AMBIENTALE LEED	14
	Classificazione LEED	14
	Protocolli LEED per le diverse tipologie di edifici	14
	LEED Nuove Costruzioni NC Italia 2009	15
	I materiali edili in LEED	16
	Il processo di certificazione	18
	Punti di forza del sistema LEED	18
6.	CONFRONTO TRA I DUE PROTOCOLLI	19

### SECONDA PARTE - Schede di valutazione prodotti YTONG

1.	Blocco YTONG CLIMA	21
2.	Risposta di YTONG CLIMA ai criteri del Protocollo ITACA Nazionale 2011	27
3.	Risposta di YTONG CLIMA ai criteri del Protocollo LEED NC 2009	35
4.	Pannello isolante minerale Multipor	41
5.	Risposta di Multipor ai criteri del Protocollo ITACA Nazionale 2011	47
6.	Risposta di Multipor ai criteri del Protocollo LEED NC 2009	55

A cura di Arch. Daniela Petrone – Libero professionista e Vicepresidente ANIT

Tutti i diritti sono riservati.  
Nessuna parte di questo documento può essere riprodotta senza l'autorizzazione scritta di ANIT.  
Le informazioni relative al contenuto di questa pubblicazione sono da ritenersi indicative.  
Sul sito [www.anit.it](http://www.anit.it) nella sezione "Manuali" sono disponibili altri documenti di approfondimento.  
Edito da TSP srl, Via Sivona 1/9 - 20144 Milano - ottobre 2012

ANIT Associazione Nazionale per l'Isolamento Termico e acustico

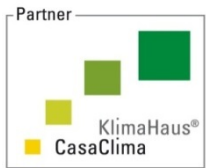

AM ©

## Riciclaggio del AAC (recupero scarti cantiere)



In Xella Belgio, circa il 20% della sabbia in fabbrica è sostituita da blocchi Ytong riciclati da cantieri nei quali Xella lascia delle RECYCLING BAGS.

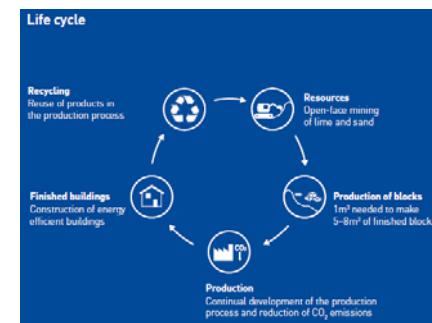

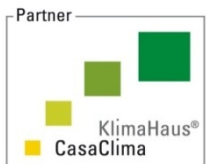

AM ©

# Fine del ciclo di vita e possibili riutilizzi

Fertilizzanti	Sottofondi a secco	Lettiere per gatti
 <p><b>AAC-based Fertilizers</b> Source: ILU Nuthetal / German Autoclaved Aerated Concrete Association, 2010</p>		

# Smaltimento in discarica

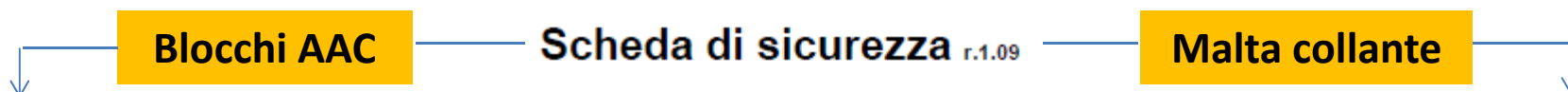

### 13. Considerazioni sullo smaltimento

I rifiuti di calcestruzzo aerato autoclavato, possono essere conferiti a discariche per rifiuti inerti. Categoria di discarica 1. Codice rifiuti: 31409 rifiuti di edilizia secondo il Catalogo dei rifiuti LAGA, 170101 secondo il Catalogo Europeo dei Rifiuti.

Imballaggio: i teli da imballaggio in polietilene ed i pallets in legno sono riciclabili.

### 13. CONSIDERAZIONI SULLO SMALTIMENTO

Conferire a discariche per rifiuti inerti (n. 170107).  
 Smaltimento prodotto in polvere: discarica di classe 2.  
 Smaltimento prodotto indurito: discarica di classe 3.

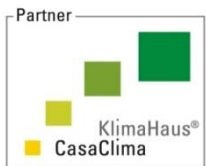

AM ©

## Fine del ciclo di vita e possibili riutilizzi ... “creativi”



# GRAZIE PER LA VOSTRA ATTENZIONE

Ing. Alessandro Miliani  
alessandro.miliani@xella.com  
346 000 9265

## Organizza

**MDS**  
MACRO  
DESIGN  
STUDIO

solutions for sustainable  
architecture

## In collaborazione con



**ROCKWOOL®**  
FIRESAFE INSULATION

## Con il patrocinio di

*fondazione*  
architetti  
e ingegneri  
liberi  
professionisti  
iscritti  
INARCASSA



Ordine degli Architetti  
Pianificatori, Paesaggisti  
e Conservatori  
della Provincia di Trento



## In cooperazione con



Collegio dei Periti Industriali e  
dei Periti Industriali Laureati  
della Provincia di Trento